

更改	出图日期	设计内容	修改
REV	DATE	MODIFICATION	DRAWN
	2011/06/27		

环保

发布章
2016.07.28
开发部

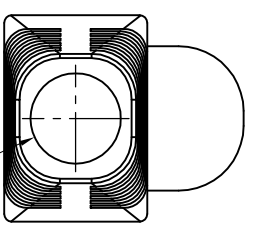
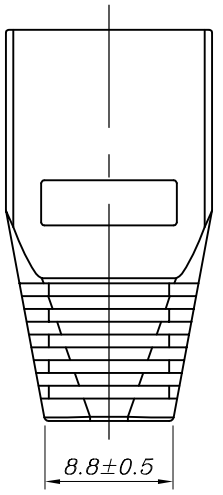
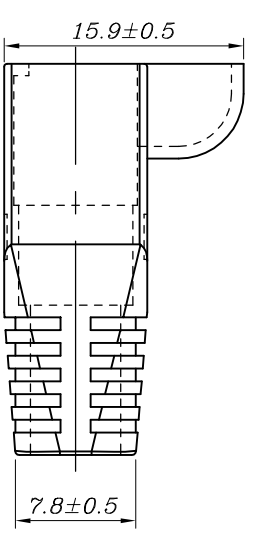
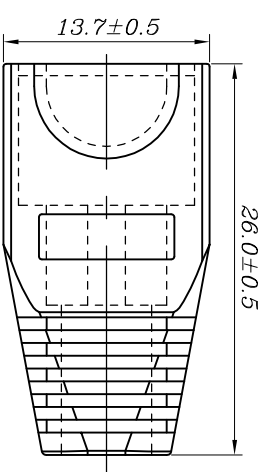
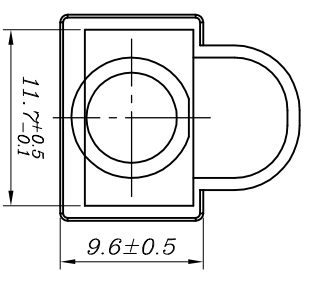
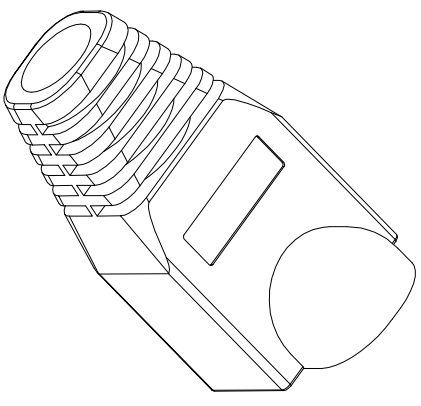

- TYYP1ø3.5
- TYYP2ø4.0
- TYYP3ø4.5
- TYYP4ø5.0
- TYYP5ø5.5
- TYYP6ø6.0
- TYYP7ø6.5

规格	单面印 线径	双面印 线径	无印字
TYYP1	ø3.5		
TYYP2	ø4.0		
TYYP3	ø4.5		
TYYP4	ø5.0		
TYYP5	ø5.5		
TYYP6	ø6.0		
TYYP7	ø6.5		

客户用产品图

宁波卓新通讯连接器有限公司
NINGBO EXCELLENCE COMMUNICATED CONNECTOR CO.,LTD

材料
MATERIAL

图号
DWG NO

名称
TITLE

比例
SCALE

审核
CHECKED

制图
DRAWN

角法
PROJ

更改
REV

DIMENSION IN mm TOLERANCE UNLESS OTHERWISE SPECIFIED	.X±0.20	.X°±5°	名称 TITLE	C5E8C6半圆型护套
OTHERWISE SPECIFIED	.XX±0.10	.XX°±2°	图号 DWG NO	ASSEMBLY.SR-309
审核 APPROVAL	沈红波	核对 CHECKED	制图 DRAWN	比例 SCALE
			钟均江	2/1
			LiWenjuan	张数 SHEET
				1/1
				更改 REV
				C

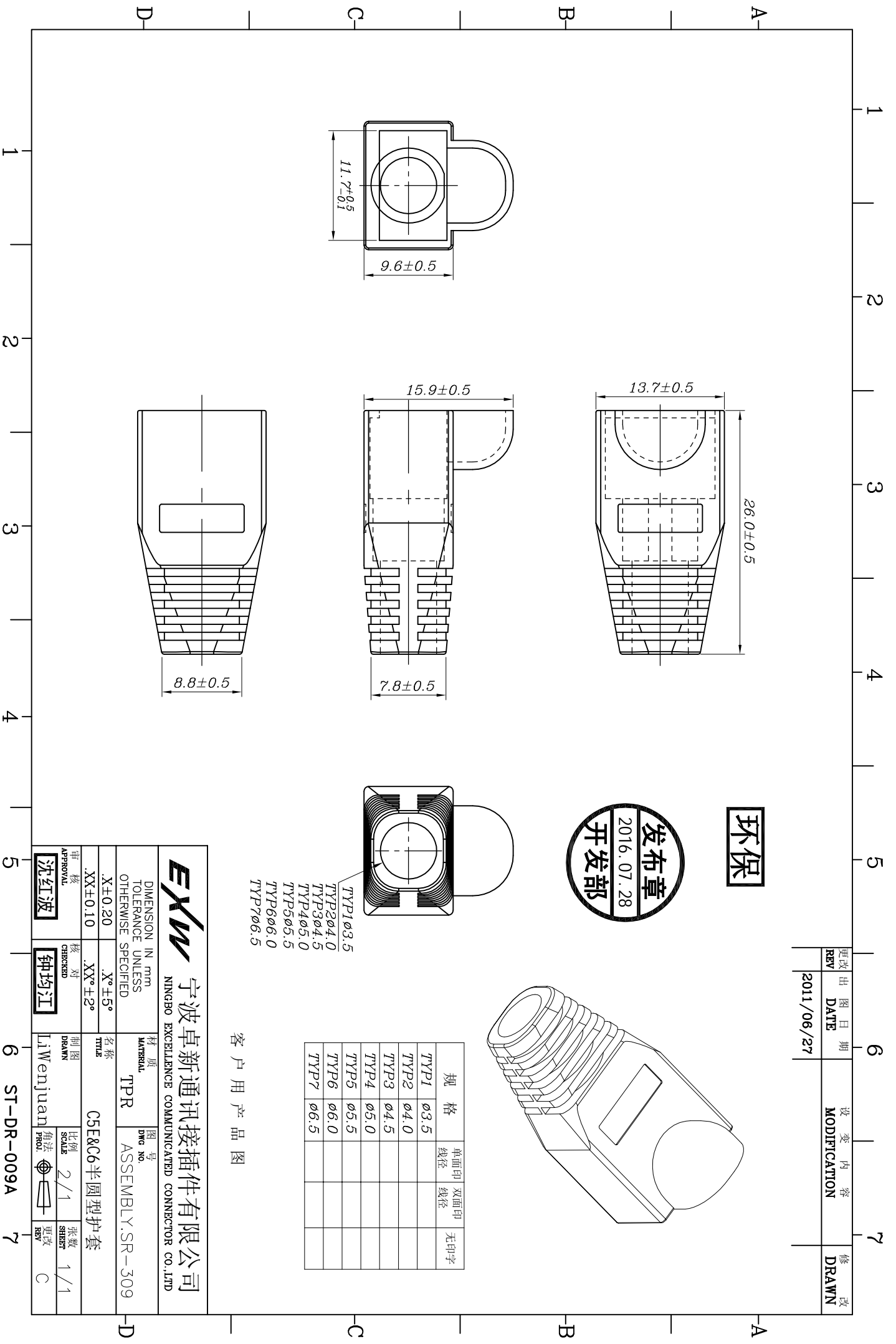

6 ST-DR-009A 7